

Make sure that you have:

- An OBD2 standard compatible vehicle
- A computer with Windows 7/8/10
- An internet connection (or a [predownloaded configurator pack](#))
- A USB A to USB mini cable
- An [OBD2 harness](#) (recommended)

Device overview

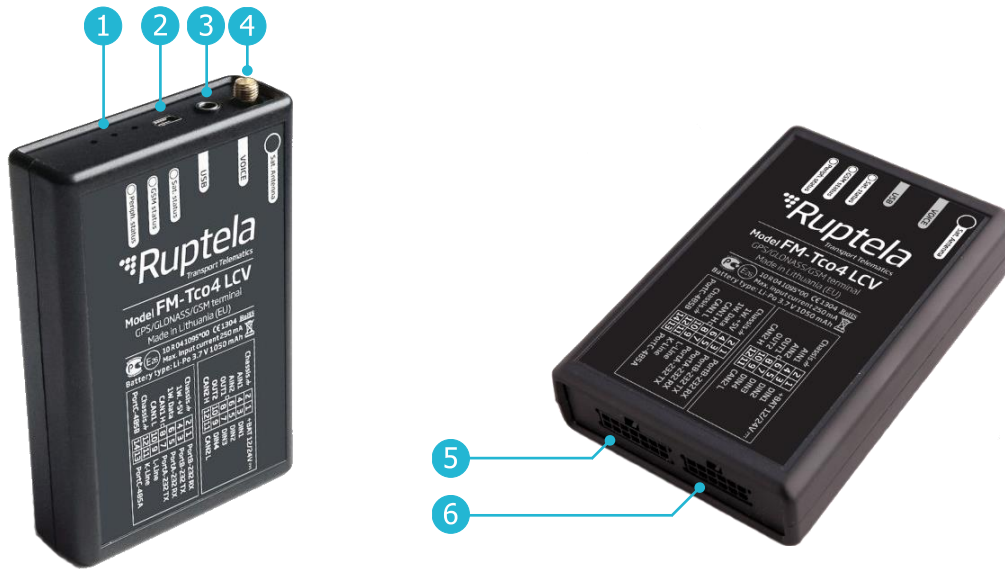

- | | | | | | |
|---|-------------------|---|---------------|---|-------------|
| 1 | Indication LEDs | 2 | Mini USB port | 3 | Audio jack |
| 4 | GNSS antenna port | 5 | 14 Pin port | 6 | 12 Pin port |

Indication LED patterns

LED	Pattern	Description
GNSS	Once every second	Accurate signal
	Once every 0.4 seconds	No signal
GSM	Once every 4 seconds	Accurate signal
	Once every 0.2 seconds	No signal
	Always on	Link with the server is open
Peripheral	Always off	No devices connected
	Once every 5 seconds	One device connected
	Twice every 5 seconds	Two devices connected
	Three times every 5 seconds	Three devices connected
All	Once every 5 seconds	Sleep/deep sleep mode

Device pinout

No.	Pin	Wire color	Description
1	+BAT 12/24V	Red	Power supply 12/24 V
2	Chassis	Black	Ground connection
3	DIN1	Pink	Digital input 1
4	AIN1	Grey	Analog input 1
5	DIN2	Blue	Digital input 2
6	AIN2	Green	Analog input 2
7	DIN3	White	Digital input 3
8	DOUT1	Purple	Digital output 1
9	DIN4	Yellow	Digital input 4
10	DOUT2	Orange	Digital output 2
11	CAN2 L	Blue/Red	CAN Low
12	CAN2 H	White/Red	CAN High

No.	Pin	Wire color	Description
1	PortB-232 RX	Yellow	RS232 RX
2	Chassis	Black	Ground connection
3	PortB-232 TX	Orange	RS232 TX
4	1W. +5V	Red	1-Wire power
5	PortA-232 RX	Purple	RS232 RX
6	1W. Data	Green/Yellow	1-Wire data
7	PortA-232 TX	Pink	RS232 TX
8	CAN1 H	White	CAN High
9	L-Line	Green	CAN L-Line
10	CAN1 L	Blue	CAN Low
11	K-Line	Brown	CAN K-Line
12	Chassis	Black	Ground connection
13	PortC-485 A	White/Red	RS485 line A
14	PortC-485 B	Yellow/Brown	RS485 line B

Start using in quick 12 steps

- Download and install the latest [VCOM drivers](#). Download the device [configurator](#).

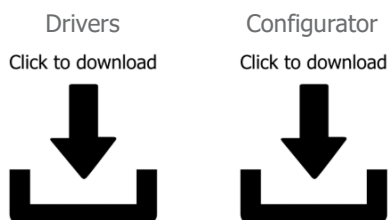

- Download the [sample config file](#). Click **File** -> **Open CFG** to load the config file. Or use **New CFG wizard** to create a new config.

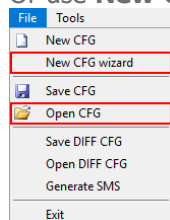

- Connect the device to your computer using a USB cable. Start the configurator. Select the port you connected your device to. Click **Connect** in the configurator.

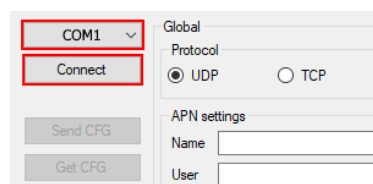

- Configure GSM provider **APN** settings. Configure Fleet Management System **Connection** settings.

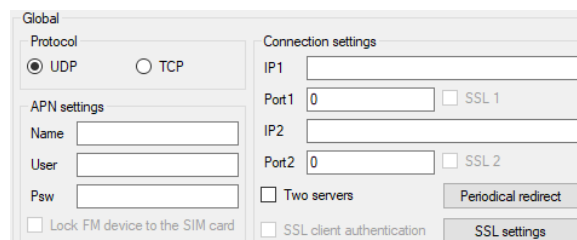

- 5 Click **Options** in **IO events**.
In **Interfaces**, tick the CAN interface you will connect to (if you have a harness, tick **CAN2**). Select **OBD** in the drop-down list. Click **Config**.

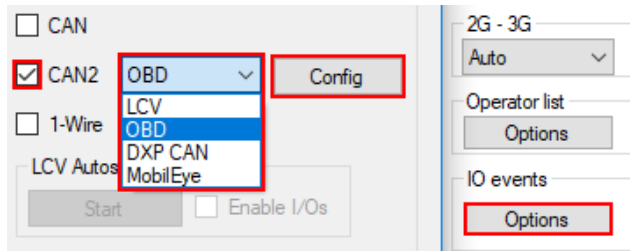

- 6 Tick the **Manufacturer specific data** checkbox.
Select your vehicle's **Manufacturer** or leave it as **Auto-detect** (will only work if the vehicle's VIN is received).

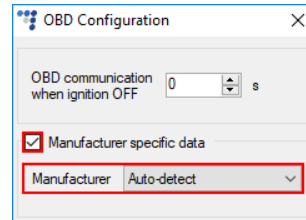

- 7 Enable the v1.1 protocol on the top right side of **IO settings**.

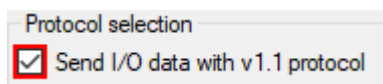

- 8 Select a parameter slot on the top left side of **IO settings**.
Select an OBD parameter in **ID**.
Tick the **Enable** checkbox.
Repeat for all necessary OBD parameters.

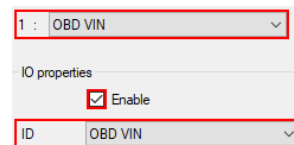

- 9 Click **Send CFG** to upload the config to the device.

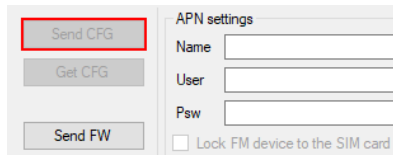

- 10 Locate the OBD port in your vehicle.
It is usually located on the driver side underneath a panel, as shown in the image below.

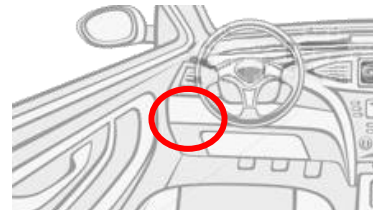

- 11 Install the device in the vehicle using zip-ties.
Make sure it is secured tightly.
Connect the device according to the wiring diagram (on Page 4).



- 12 Install the GNSS antenna directed upwards.
Follow the recommendations:

- Install behind the dashboard
- Install as close to the window as possible
- Avoid installing near metal surfaces



Wiring diagram

- Power input 12/24 V DC

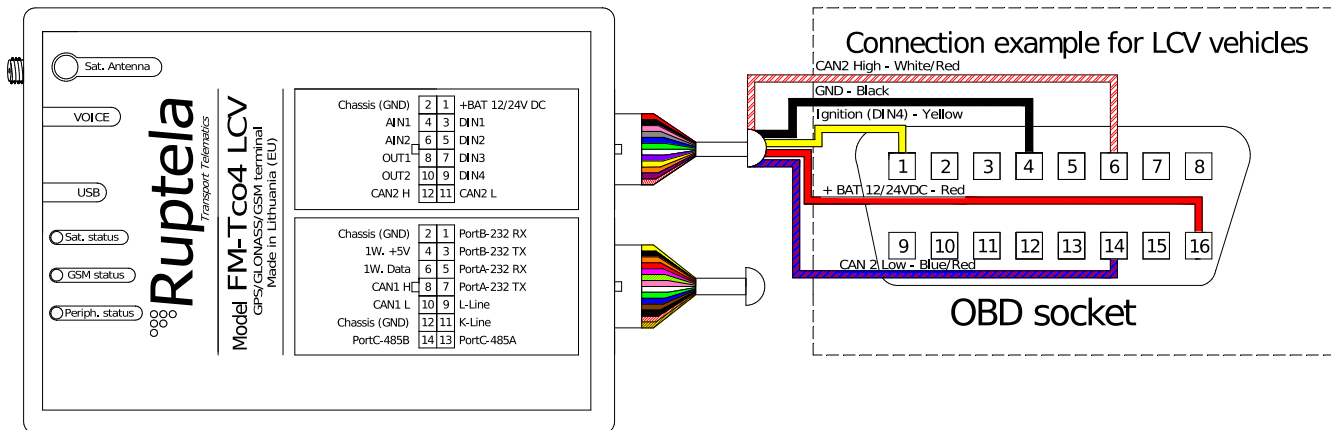

Supported OBD2 parameters list

IO ID	Description	IO ID	Description
93	DTC and MIL status	101	Actual engine – percent torque, %
94	RPM	102	Distance travelled while MIL is activated, km
95	Vehicle speed sensor, km/h	103	Relative accelerator pedal position, %
96	Engine coolant temperature, °C	104-106	VIN code
97	Ambient air temperature, °C	107	Time since engine start, s
98	Fuel level, %	108	DTC counted
99	Type of fuel	642	Fuel level, l
100	Engine fuel rate, l/h	645	Odometer, km

Further reading

- Documentation website: <http://doc.ruptela.com>
- List of supported OBD2 vehicles: <https://doc.ruptela.it/display/AB/OBD>
- Datasheet: <https://doc.ruptela.it/pages/viewpage.action?pageId=884777>
- User manual: <https://doc.ruptela.it/pages/viewpage.action?pageId=884777>
- Windows drivers: <https://doc.ruptela.it/display/AB/FM4+drivers>
- Configurator tool: <https://doc.ruptela.it/pages/viewpage.action?pageId=884804>

We highly recommend you to read the user manual before using the device.

Legal information

Copyright © 2019 Ruptela. All rights reserved. Reproduction, transfer, distribution or storage of parts or all of the contents in this document in any form without the prior written permission of Ruptela is prohibited. Other products and company names mentioned in this document are trademarks or trade names of their respective owners.